

RSCDS DUNS & DISTRICT BRANCH
 Scottish Charity Number SC005726

MAY WEEKEND

Volunteer Hall Duns
 Friday 17th May 2024

Reception 6.30pm

Jim Lindsay and his Band

EH3 7AF Jig 8 X 32 40/6

EH3 7AF					8x32 J
	1 2 3 PROM ↻			2 1 1 3 RA	

Roy Goldring, 1998, RSCDS Book 40.6 3C/4C longwise set.

ORPINGTON CALEDONIANS Reel 8 X 32 49/2

ORPINGTON CALEDONIANS					8x32 R
S			3 1x 	2 1 RA	

John Brenchley, 1987, RSCDS Book 49.2 3C/4C longwise set.

MISS GIBSON'S STRATHSPEY Strathspey 8 X 32 L/let1

MISS GIBSON'S STRATHSPEY					8x32 S
1 2 S T _B	4	1 2 KNOT			

Derek Haynes, 1979, RSCDS Leaflet 10 3C/4C longwise set.

SOUR LEMON (THE) Jig 8 X 40 Ashby

THE SOUR LEMON				8x40 J
S				
1 3 RA	2 1 LA	2 1 3 	2 1 3 	6

John and Hilary Ashby, 2001, https://dances.e-cribs.org/brisport/The_Sour_Lemon.pdf 3C/4C longwise set.

TOAST TO THE MOUSIES Reel 8 X 32 53/1/7

TOAST TO THE MOUSIES				8x32 R
				2 1 3 S

Sara Gratiot, 2016, RSCDS Book 53 3C/4C longwise set.

UP IN THE AIR Strathspey 8 X 32 20/2

UP IN THE AIR					8x32 S
	1 2 3 PROM ↻	S	2 1 x 3 6		2 1 x 3 T _B to own sides

Boag, 1797, RSCDS Book 20.2 3C/4C longwise set.

GOTHENBURG'S WELCOME Jig 8 X 32 37/3

GOTHENBURG'S WELCOME					8x32 J
1	S	to			
			2 1 3 RA	2 1 3 T _R	

Bobby Munro, RSCDS Book 37.3 3C/4C longwise set.

DUNS DAISY CHAIN Strathspey 4 X 32 Wilkinson

DUNS DAISY CHAIN					4x32 S
1 2 3 4 4	1 2 3 4 S & LINK	2 1 4 		2 4 1 3 	1x T _L 1 1/2
Bourrel 		4-4 1-1 to: 2 4 1 3 S T _B 3/4			

John Wilkinson, 2023 4C/4C longwise set.

MRS MACPHERSON OF INVERAN Reel 8 X 32 Drewry

MRS MACPHERSON OF INVERAN					8x32 R
		T _R 1 1/2 to 2 1 x		CHAIN	2 1 3 6

John Drewry, 1964, Bon Accord Book 3C/4C longwise set.

Interval

MACHINE WITHOUT HORSES (THE) Jig 8 X 32 12/12

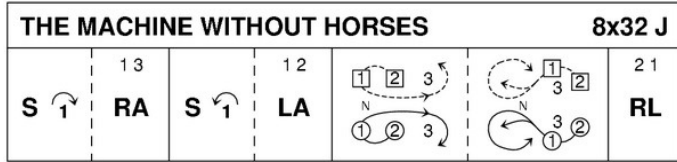

Rutherford, 1772, RSCDS Book 12.12

3C/4C longwise set.

LADIES OF DUNSE (THE) Reel 8 X 40 26/11

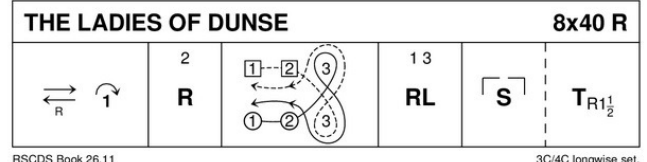

RSCDS Book 26.11

3C/4C longwise set.

LOCHALSH REEL (THE) Reel 8 x 40 53/1

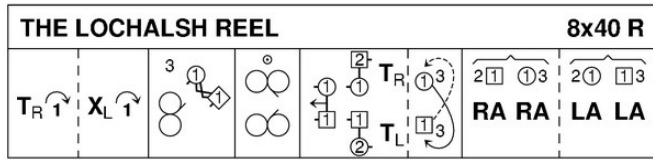

Pat Burnett, RSCDS Book 53, Skye Collection 2

3C/4C longwise set.

ORCHARDS OF CO. ARMAGH (THE) Strathspey 3 X 32 3cpl 53/14

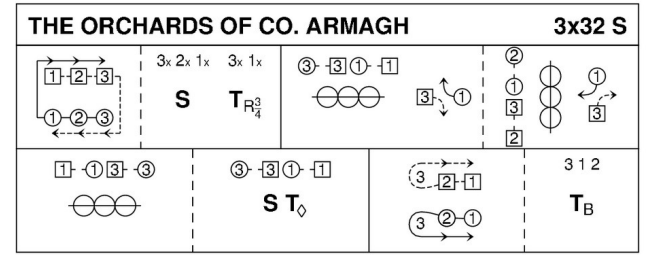

Jinty Anderson, Belfast Platinum Anniversary

3C/3C longwise set.

GENTLEMAN (THE) Strathspey 8 X 32 30 Pop Vol2/56

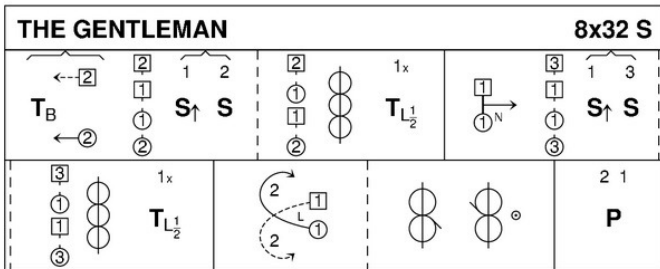

Roz Scott Huxley, 1986, RSCDS Book 35.5, RSCDS Thirty Popular Dances Vol 2

3C/4C longwise set.

REEL OF THE ROYAL SCOTS (THE) Reel 8 X 32 L/27

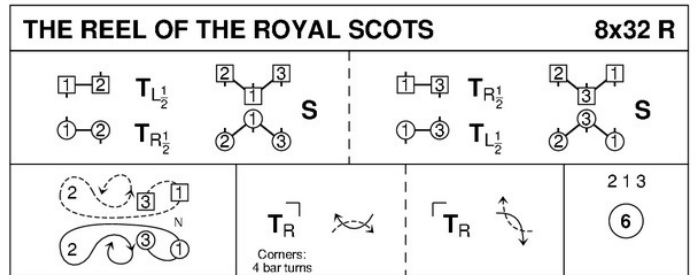

Foy Goldring, 1983, RSCDS Leaflet 7

3C/4C longwise set.

VINTAGE SIMON Jig 5 X 32 5cpl 47/5

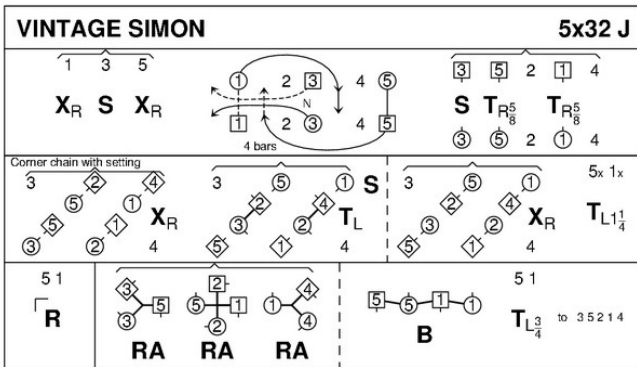

Dorothy Hargreaves, RSCDS Book 47.5

5C/5C longwise set.